

**SAS 35 SLOTTED HEADER - REG**  
**LIVE AREA - 22 5/8" W X 9" H**



*NYSCO Products, LLC*  
*2350 Lafayette Avenue*  
*Bronx, New York 10473*  
*Tel. 718-792-9000*  
*Fax: 718-792-7732*  
*WWW.NYSCO.COM*



**HORIZONTAL BLEED ADD 1 3/4" LEFT & RIGHT**  
**VERTICAL BLEED ADD 1/4" TOP & BOTTOM**  
**OVER ALL SHEET SIZE - 25 3/4" W X 9" H**  
**SUBSTRATE - .048 SBS**  
**SCALE - FULL SIZE**

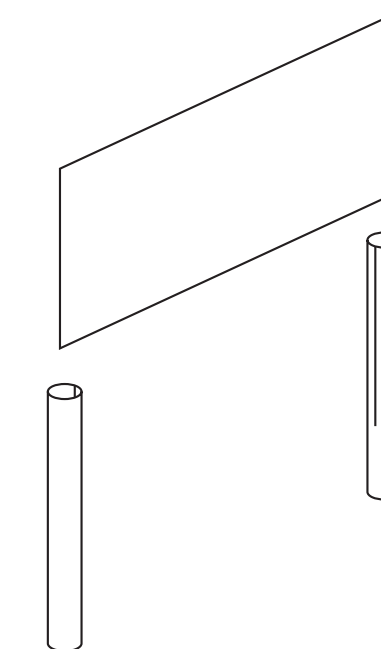

**FRONT VIEW OF SLOTTED HEADER**