

SAS 31 FOLD OVER HEADER - TALL
LIVE AREA - 24 11/16" W X 12" H

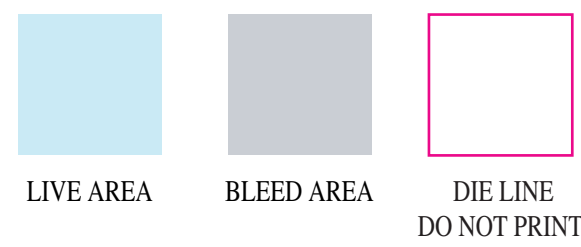

NYSCO Products, LLC
2350 Lafayette Avenue
Bronx, New York 10473
Tel. 718-792-9000
Fax: 718-792-7732
WWW.NYSCO.COM



HORIZONTAL BLEED ADD 1/4" LEFT & RIGHT
VERTICAL BLEED ADD 3" TOP & BOTTOM
OVER ALL SHEET SIZE - 24 11/16" W X 22 5/8" H
SUBSTRATE - .024 SBS
SCALE - FULL SIZE

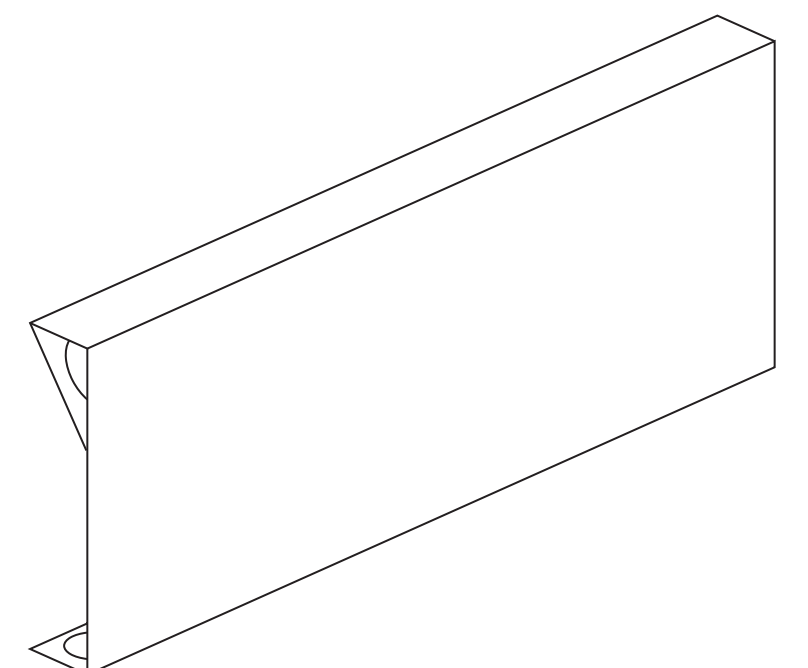

FRONT VIEW OF FOLDED HEADER