

SAS 26 FOLD OVER HEADER - REG
LIVE AREA - 20 7/8" W X 9" H

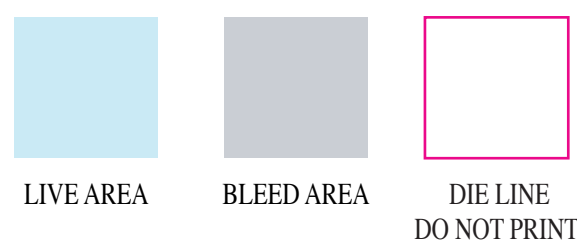

NYSCO Products, LLC
 2350 Lafayette Avenue
 Bronx, New York 10473
 Tel. 718-792-9000
 Fax: 718-792-7732
 WWW.NYSCO.COM



HORIZONTAL BLEED ADD 1/4" LEFT & RIGHT
VERTICAL BLEED ADD 3" TOP & BOTTOM
OVER ALL SHEET SIZE - 20 7/8" W X 19 7/8" H
SUBSTRATE - .024 SBS
SCALE - FULL SIZE

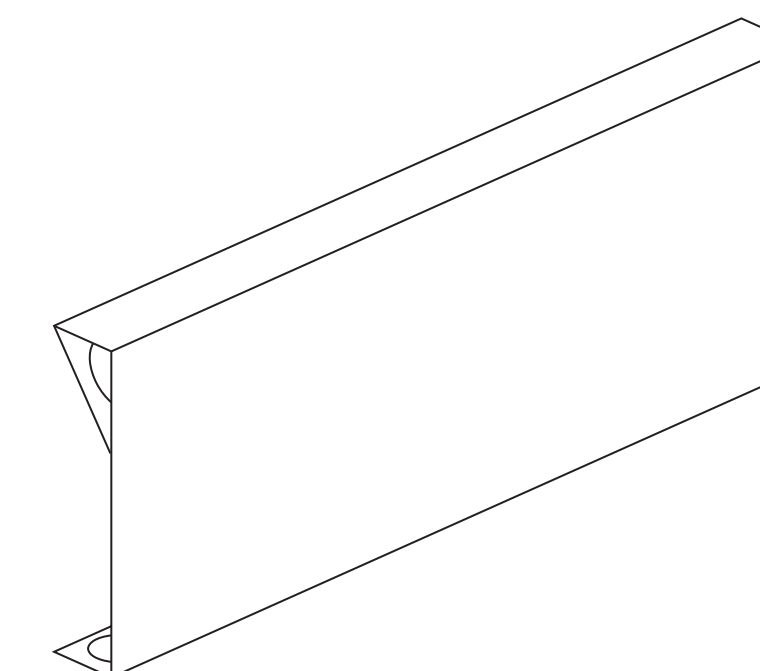

FRONT VIEW OF FOLDED HEADER