

*NYSCO Products, LLC
2350 Lafayette Avenue
Bronx, New York 10473
Tel. 718-792-9000
Fax: 718-792-7732
WWW.NYSCO.COM*

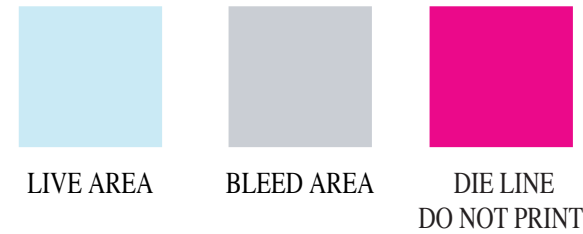

**HORIZONTAL BLEED ADD 1 3/4" LEFT & RIGHT
VERTICAL BLEED ADD 1/4" TOP & BOTTOM
OVER ALL SHEET SIZE - 21 5/16" W X 9" H
SUBSTRATE - .048 SBS
SCALE - FULL SIZE**

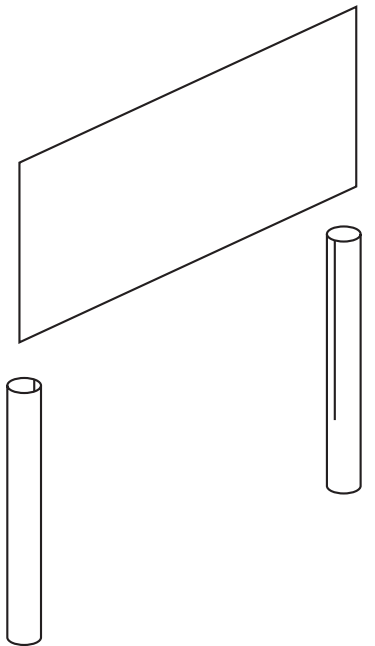

FRONT VIEW OF SLOTTED HEADER