

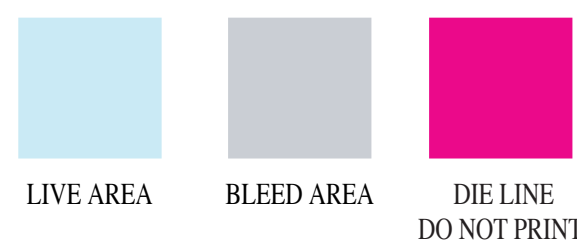

**SAS 16 FOLD OVER HEADER - REG**  
**LIVE AREA - 26 1/2" W X 9" H**



*NYSCO Products, LLC*  
2350 Lafayette Avenue  
Bronx, New York 10473  
Tel. 718-792-9000  
Fax: 718-792-7732  
WWW.NYSCO.COM



**HORIZONTAL BLEED ADD 1/4" LEFT & RIGHT**  
**VERTICAL BLEED ADD 3" TOP & BOTTOM**  
**OVER ALL SHEET SIZE - 26 1/2" W X 19 9/16" H**  
**SUBSTRATE - .024 SBS**  
**SCALE - FULL SIZE**

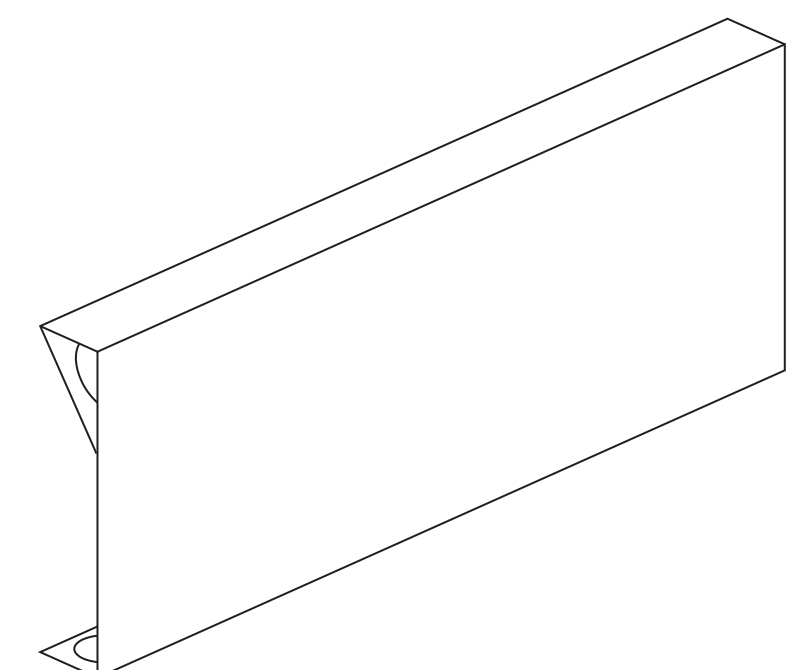

**FRONT VIEW OF FOLDED HEADER**