

SAS 5 TAPE ON BACK HEADER - TALL
LIVE AREA - 20 1/2" W X 12" H

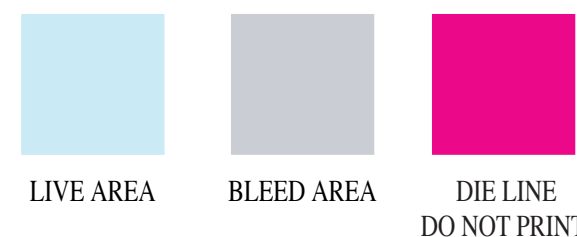

NYSCO Products, LLC
2350 Lafayette Avenue
Bronx, New York 10473
Tel. 718-792-9000
Fax: 718-792-7732
WWW.NYSCO.COM



HORIZONTAL BLEED ADD 1/4" LEFT & RIGHT
VERTICAL BLEED ADD 1/4" TOP & BOTTOM
OVER ALL SHEET SIZE - 20 1/2" W X 12" H
SUBSTRATE - .048 SBS
SCALE - FULL SIZE

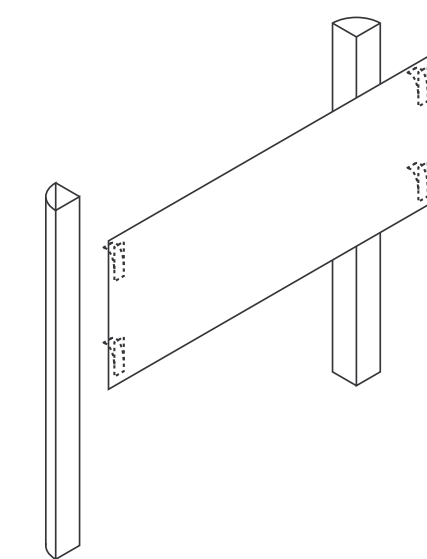

FRONT VIEW OF TAPE ON BACK HEADER